



TV Listening System

USER MANUAL

1-888-327-1299

www.EarTechTVAudio.com

COMPONENT PART LIST

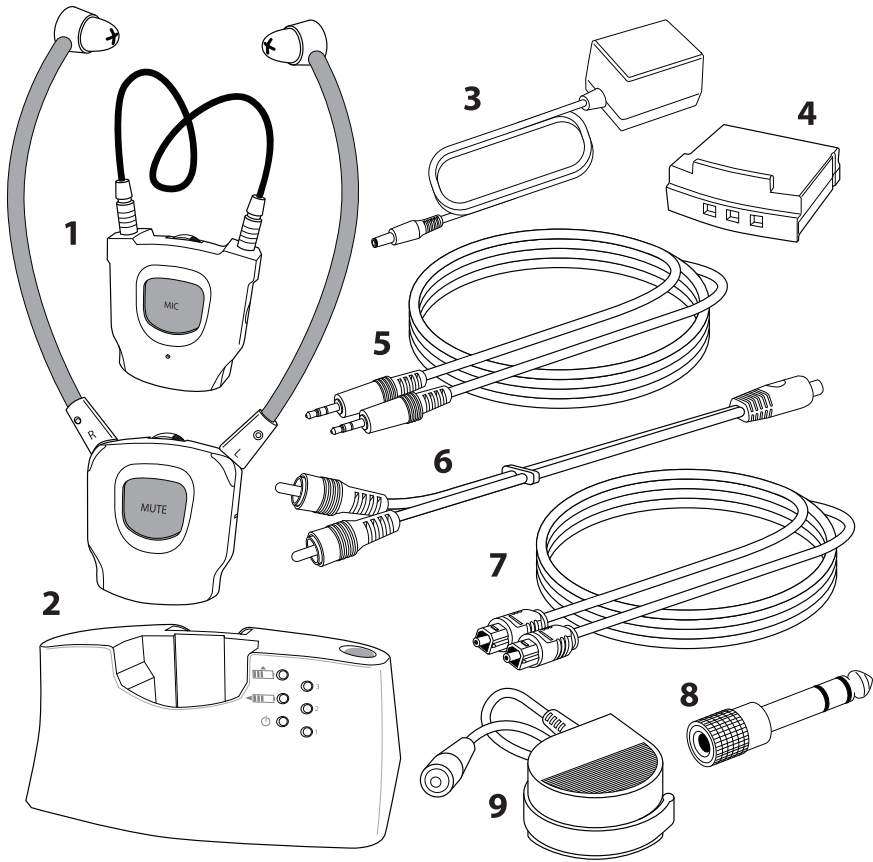

1. Headset Receiver or Neckloop Receiver
2. Transmitter
3. Power Supply Cable
4. Battery (x2)
5. Audio Cable (3.5mm stereo plug)
6. RCA Adapter Cable
7. TOSLINK Optical Cable
8. 6.3mm (1/4") to 3.5mm Adapter Plug
9. External Microphone

Setup

1. Plug in transmitter (base station).

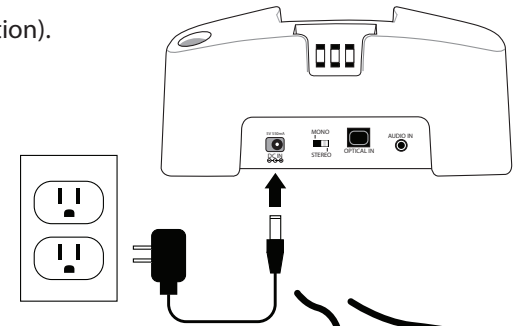

2. Insert battery into bottom of receiver.

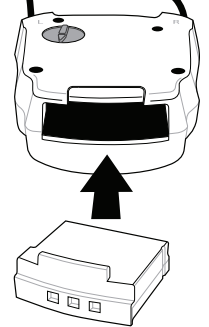

3. Place receiver in transmitter base to charge overnight (or at least 3 hours).

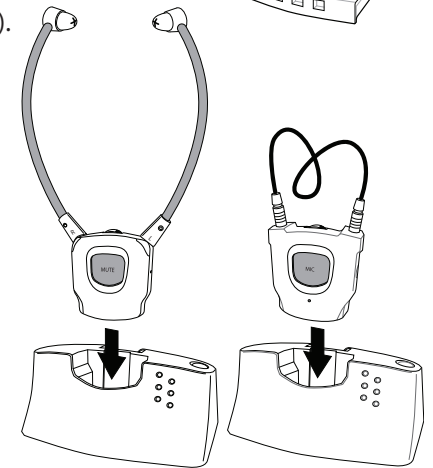

4. Check to see which type of audio output your TV has. Connect transmitter to TV by following the appropriate illustration in the set-up guide.

5. Enjoy!

How to use: EarTech TV Audio with under-the-chin Headset Receiver

1. Turn on your sound source (e.g. TV).
2. While wearing the headset, adjust the volume level initially to a low volume to protect your hearing. The volume increases when you turn the dial toward "10" and it decreases when you turn the dial in the direction of "0".
3. Turn the headset on with the switch on the side. The flashing green LED indicates that the receiver is switched on. The LED will be solid green once a signal is received from the sound source. **If the green LED continues to flash after one minute, refer to pg. 11 for pairing instructions.**
4. Set the desired volume on your headset.
5. We recommend that you turn off the headset and place back into the transmitter cradle when not in use, to ensure that the battery is always charged.

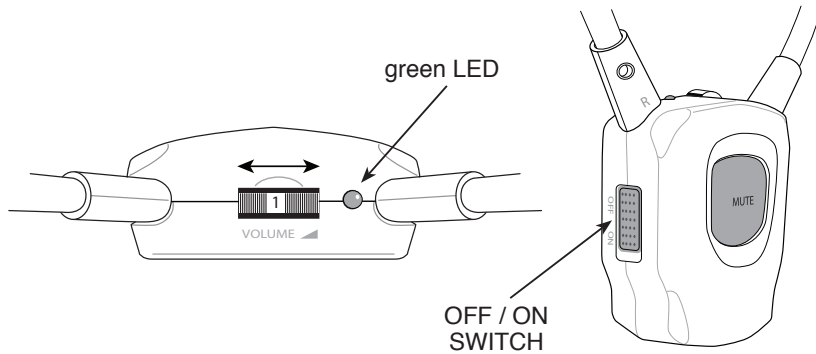

How to use: EarTech TV Audio Neckloop Receiver

CAUTION: If you have a heart pacemaker, contact your physician or the manufacturer of the pacemaker before using the neckloop, to ensure that the pacemaker is not subject to interference.

1. Turn on your sound source (e.g. TV), and switch your hearing aids to T-coil setting.
2. Adjust the volume level on the neckloop initially to a low volume to protect your hearing.
3. The neckloop lock is used to safely wear the device and is designed to release to minimize accidents. Ensure that the neckloop lock has been closed completely (see pg. 5)
4. Turn on the neckloop receiver by using the ON/OFF switch on the side of the receiver. The flashing green LED on the receiver indicates that the receiver is switched on. The LED will be solid green once a signal is received from the sound source. **If the green LED continues to flash after one minute, refer to pg. 11 for pairing instructions.**
5. Set the desired volume on your neckloop receiver.
6. We recommend that you turn off the neckloop and place back into the transmitter cradle when not in use, to ensure that the battery is always charged.

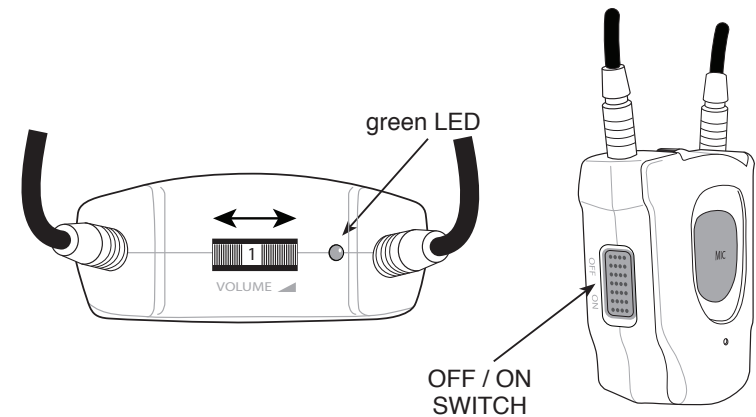

Safety lock in the Neckloop

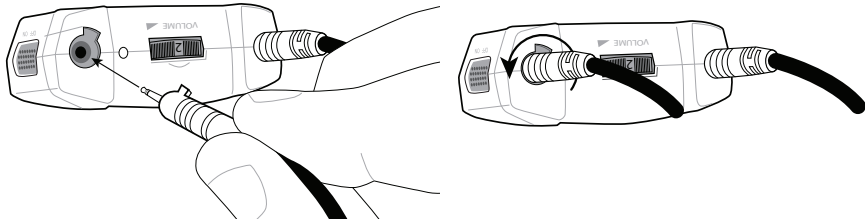

Please ensure that the safety lock is completely closed in the neckloop to guarantee proper functioning.

Listening with T-coil-equipped hearing aids (Neckloop)

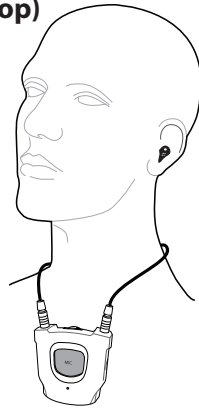

Listening with the 3.5 mm stereo output (Neckloop)

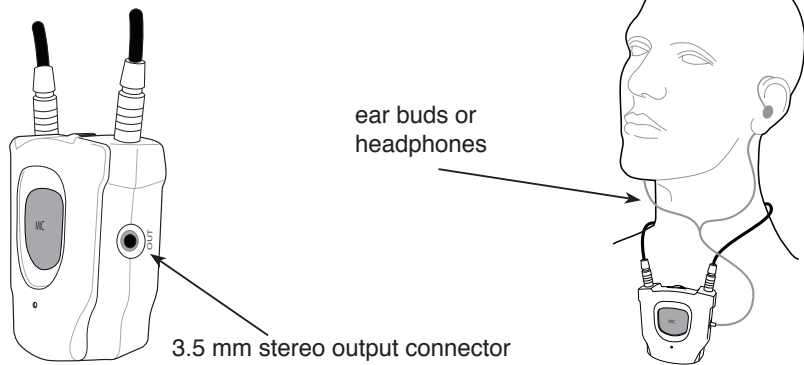

Important!

The overall operating time of the receiver can be reduced significantly depending on the listening volume and the accessories connected to the output.

Tone Presets

You can set the Tone/Clarity with the button on the transmitter. Press and release the button until you find a listening preset that is right for you.

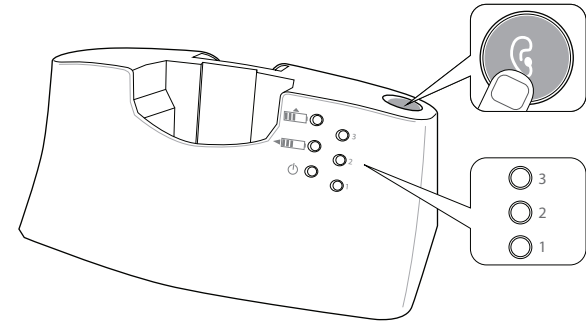

The following table shows the settings. Select which setting works best for you.

Setting	Orange LED Indicator	Effect
Default		Flat
1		Bass Boost + Treble Boost
2		Treble Boost
3		Bass Boost

Balance control

(EarTech TV Audio headset receiver and the 3.5 mm stereo output of the neckloop receiver only.)

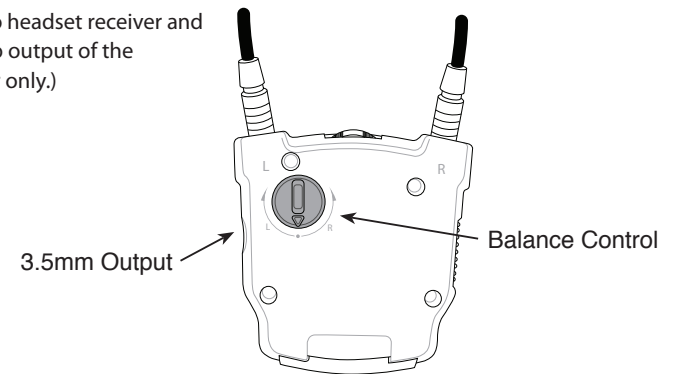

The balance controls the volume distribution between the right and the left ear with the headset or when the 3.5 mm stereo output is used on the neckloop with earbuds or headphones. Adjust the balance so that you have the same volume level in both ears.

Note regarding neckloop: If using with T-coil equipped hearing aids, you can adjust the volume and tone, but not the balance.

Volume control

Adjust the volume level on the headset initially to a low volume to protect your hearing. The volume increases when you turn the dial toward "10" and it decreases when you turn the dial in the direction of "0".

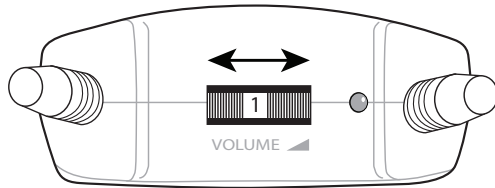

Range

EarTech TV Audio uses the newest 2.4GHz technology. In optimal cases the range is up to 30.5 meters (100 feet).

The 2.4GHz radio frequency technology also works through walls. The range depends greatly on the building and the environment.

Mono/Stereo Switch

You can switch to stereo when using the headset or the 3.5mm output on the neckloop with earbuds or headphones. When using T-coil enabled hearing aids with the neckloop, the signal will always be mono.

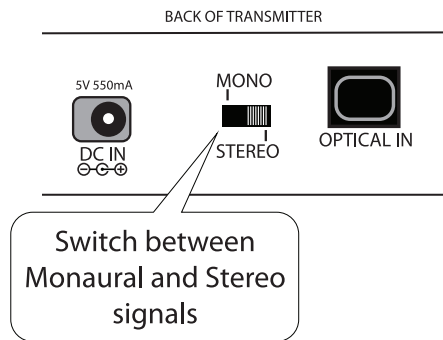

Battery charging

Once the battery is fully charged, it can be used up to six (6) hours. The operating time may vary, depending on the listening volume.

Headset: The green LED on the headset will blink slowly and beep every minute when the battery is low.

Neckloop: When the battery level is low, you will hear 3 beeps every minute in the neckloop. The neckloop will be switched off automatically after 5 minutes.

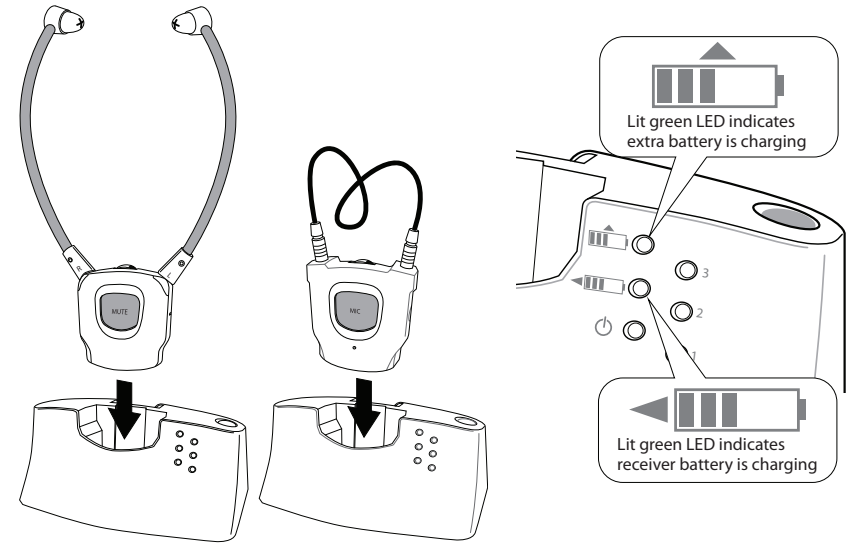

After use, gently place the receiver into the charging cradle of the transmitter.

Ensure that the receiver is placed correctly in the transmitter. If the receiver is charging, the green LED at the right side of the receiver is illuminated. For first time operation, it is recommended that the battery be charged for at least three (3) hours.

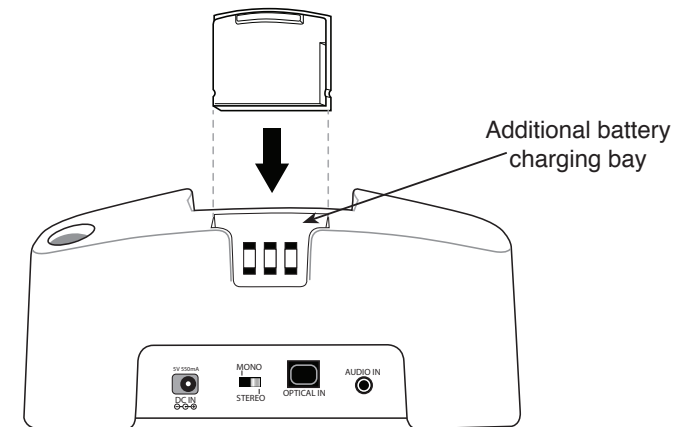

An additional battery can be charged in the transmitter. Additional batteries are available through your EarTech TV Audio distributor.

The additional battery can be inserted into the charging bay behind the receiver charging cradle. Please ensure that the sloped side points upward and that you insert it without applying too much force. The LED on the base is illuminated green when the battery is charging.

We recommend that you exchange the battery in the receiver with the spare battery in the transmitter weekly. This ensures that the batteries are used regularly and that they achieve a maximum service life.

Cleaning and care

Cleaning the transmitter and the receiver

If the device becomes dusty or dirty, you can clean it with a clean, damp cloth. Disconnect the transmitter from the power supply before cleaning.

Cleaning the silicone ear tips

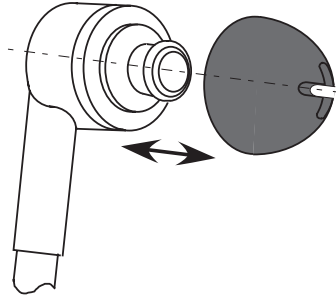

You can remove the ear tips from the headset. Clean the ear tips with mild soapy water. Dry the ear tips thoroughly and reattach them.

Replacing the silicone ear tips

The hypoallergenic silicone ear tips should be replaced if they become worn or damaged. New silicone tips can be ordered from your EarTech TV Audio distributor.

Important information

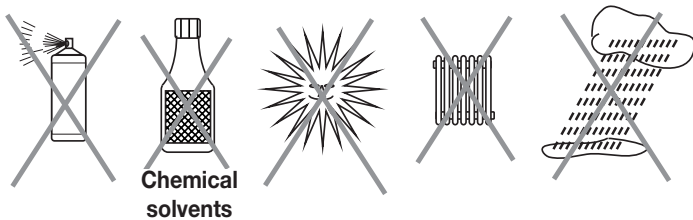

Product damage caused by improper handling as well as damage due to contamination are excluded from the warranty.

This device is not protected against moisture. Do not place objects that are filled with fluids on or near the device, e.g. vases.

Open fire sources such as burning candles, should not be placed on or near the transmitter.

Warranty

Refer to the warranty card included in the product package.

Connection guide

Connect to TV via Optical cable

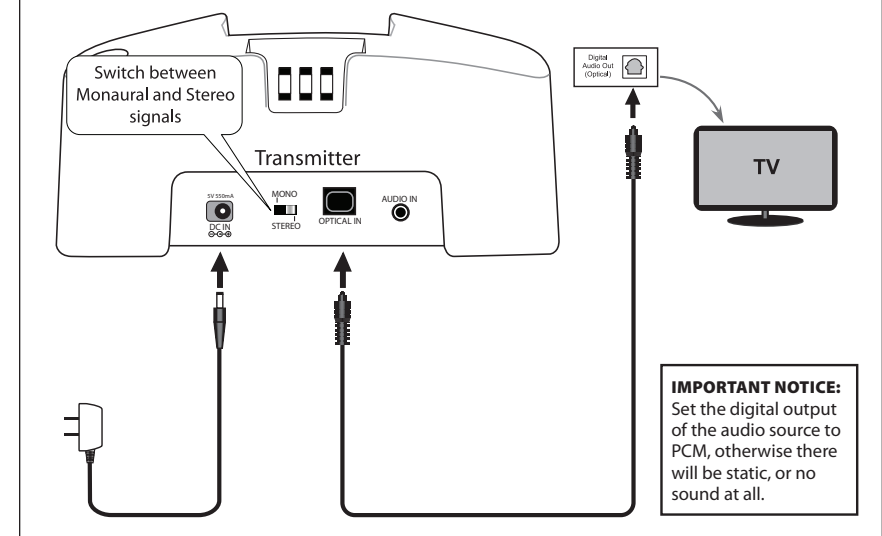

Connect to TV via RCA cable

★ **IMPORTANT:**
TV must have **Audio OUT** jacks. (Will not work on Audio IN jacks.)

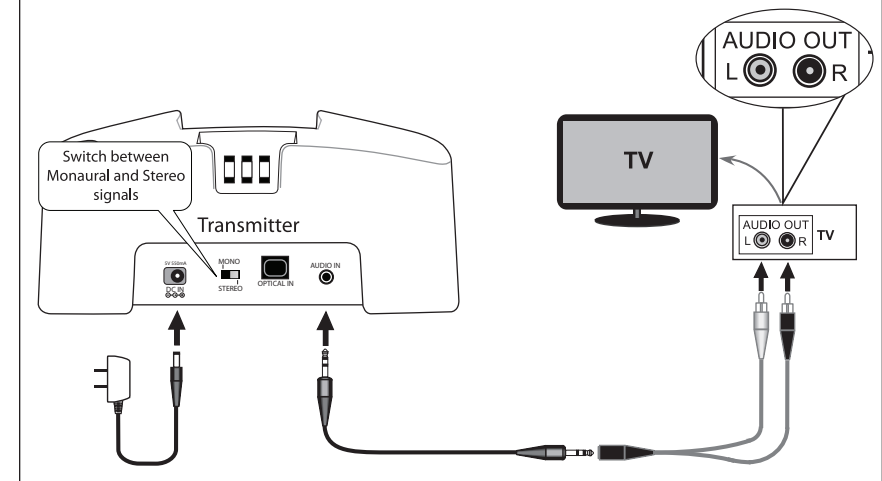

If connecting to a PC use either the headphone jack or if available, the optical audio output.

Connect to TV via single audio cable

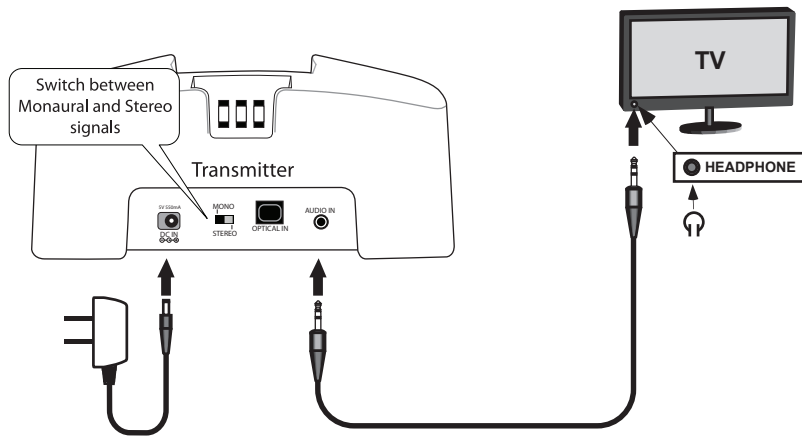

Note: Using the headphone jack may mute the TV speakers.

If other options have not been effective, plug in Microphone (included) instead of direct connection.

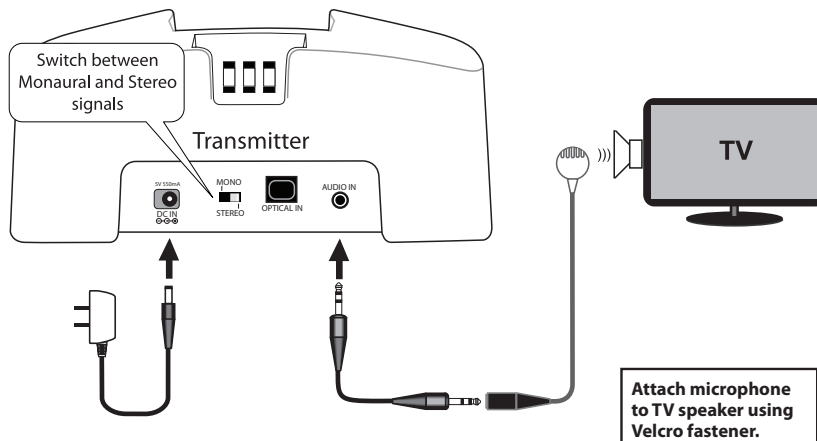

Need assistance? Call us at 1-888-327-1299 (customer support hours Monday – Friday 8:00 am – 5:30 pm ET) or email info@EarTechTVAudio.com

Troubleshooting

The Neckloop Receiver cannot be linked to the Transmitter, please follow this procedure for Pairing:

1. Turn OFF the power to the Transmitter by unplugging the power supply.
2. Turn ON the Neckloop Receiver.
3. Press and hold the MIC Button on the Receiver for 5 seconds. The green LED on the Receiver will flash quickly.
4. Turn ON the Transmitter by plugging in the power supply.
5. The Receiver and the Transmitter are then Paired automatically and the green LED on the Receiver lights steadily.
6. One Transmitter can be connected to multiple Receivers as above

The Headset Receiver cannot be linked to the Transmitter, please follow this procedure for Pairing:

1. Turn OFF the power to the Transmitter by unplugging the power supply.
2. Turn ON the Headset Receiver.
3. Press and hold the MUTE Button on the Receiver for 5 seconds. The green LED on the Receiver will flash quickly.
4. Turn ON the Transmitter by plugging in the power supply.
5. The Receiver and the Transmitter are then Paired automatically and the green LED on the Receiver lights steadily.
6. One Transmitter can be connected to multiple Receivers as above

No sound

- Ensure that the power supply is inserted in the outlet and that its cable is properly connected to the DC IN connector on the Transmitter.
- Ensure that the Receiver power ON/OFF switch is switched to ON.
- Make sure the battery is charged. If not, recharge the battery or replace it with a fully charged battery.
- Ensure that the TV set, Hi-Fi system or audio component is switched ON and set to a channel that broadcasts an audio signal.
- Use the Volume Control on the Receiver to increase the sound level.
- Try using a different connection RCA, OPTICAL or HEADPHONE.

Distortion

- The Receiver may be too far away from the Transmitter. Move the Receiver closer to the Transmitter.
- The audio signal input level may be too low. Increase the volume from the audio source.
- The audio signal input level may be too high. Lower the volume from the audio source.

TECHNICAL SPECIFICATIONS: HEADSET

Transmission mode: Digital RF System
Carrier frequency: 2.4GHz ISM BAND
Operating voltage: Transmitter 5V 550mA
Receiver 3.7 V, 350mA Lithium Polymer Battery
Frequency response: 30Hz - 20KHz
Distortion: <0.5%
Signal-to-noise ratio: >75dB
Listening time: up to 6 hours
Range: up to 25 meters (82 feet) (open area)

TECHNICAL SPECIFICATIONS: NECKLOOP

Transmission mode: Digital RF System
Carrier frequency: 2.4GHz ISM BAND
Operating voltage: Transmitter 5V
Receiver 3.7 V Lithium Polymer Battery
Frequency response: 20Hz - 20KHz
Distortion: <0.5%
Signal-to-noise ratio: >85dB
Listening time: up to 6 hours
Range: up to 30 meters (98.4 feet) (open area)



1-888-327-1299

info@EarTechTVAudio.com

www.EarTechTVAudio.com

P.O. Box 1516

Johnson City, TN 37605-1516